

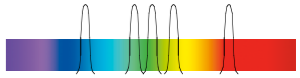

## Single frequency diode-pumped solid state laser modules



### LASOS® DPSS laser series

The LASOS® DPSS laser series is the best choice when reliability and long lifetime matters. The special optical design and an intelligent power and temperature control guarantee

- Excellent long-term stability
- Low noise
- Exceptional good beam quality
- Long lifetime

These characteristics are ideal for a variety of applications as in DNA sequencing, flow cytometry, digital imaging, analytical chemistry, fast-flow-rate particle measurements or confocal microscopy. Since all laser models emit only a single longitudinal mode they are also an ideal choice for application in RAMAN-spectroscopy. Housed in compact and robust packages, these lasers are the perfect choice for design in and integration into OEM instrumentation and systems and also for end user applications in research and development. The lasers will be provided as self-contained laser modules, as OEM-component modules or as fully integratable subsystems, with a compact controller as OEM or stand alone version with computer interfacing.

Customized solutions for specific applications are possible. All laser models can be provided with a polarization maintaining, adjustment free fiber coupling.

### DPSS laser

|  | BLK ▼     | GLK ▼                      | GLK ▼      | YLK ▼      | RLK ▼                      |
|--|-----------|----------------------------|------------|------------|----------------------------|
| Wavelength [nm]                                  | 473.1±0.3 | 532.3±0.3                  | 540.0±1    | 561.3±0.3  | 639.6±0.5                  |
| Output power [mW]                                | 5,10      | 20, 50, 75, 100            | 20, 50     | 20, 50, 75 | 50, 75, 100                |
| Beam diameter [mm]                               | 0.7       | 0.7 / 0.32                 | 0.7 / 0.32 | 0.7        | 0.7                        |
| Beam divergence [mrad]                           | < 1.1     | < 1.2                      | < 1.2      | < 1.3      | < 1.4                      |
| Beam Ellipticity                                 |           | 0.9...1.1                  |            |            | 0.9...1.1                  |
| Beam quality M <sup>2</sup> (TEM <sub>00</sub> ) |           | < 1.2 (TEM <sub>00</sub> ) |            |            | < 1.2 (TEM <sub>00</sub> ) |
| Output power stability over 8 h                  |           | < ± 1%                     |            |            | < ± 1%                     |
| Wavelength stability during 8 h                  |           | < ±0.002 nm                |            |            | < ±0.002 nm                |
| Pointing stability                               |           | < 6 μrad/K                 |            |            | < 6 μrad/K                 |
| Line width                                       |           | < 5 MHz                    |            |            | < 5 MHz                    |
| Optical noise (30 Hz-10 MHz)                     |           | < 0.5 % rms                |            |            | < 2 % rms                  |
| Polarization ratio (vertical)                    |           | > 200:1                    |            |            | > 200:1                    |
| Warm up time                                     |           | < 10 min                   |            |            | < 10 min                   |

### Model key for orders and enquiries:

Model - Wavelength - Output power - Beam diameter - Controller - Cable length, or other options  
(example: GLK - 532.3 - 50 - 0.32 - 2)

### Dimensions laser head [mm]:

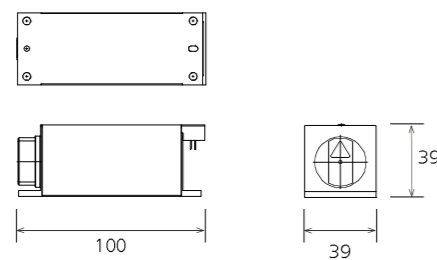

### Fiber coupled version:

|                     |   |
|---------------------|---|
| Fiber type          | Single mode, polarization maintaining                           |
| Fiber jacket        | 3 mm PVC, optional: 5 mm steel-reinforced, 5 mm stainless steel |
| Output connector    | FC or customized  |
| Coupling efficiency | > 70%   |

### Dimensions laser head fiber coupled [mm]:

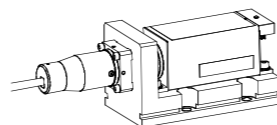
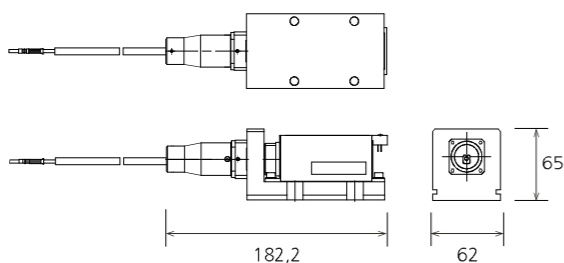

### Controller

|  | CKL 2400                          | CKL 1000              |
|--|-----------------------------------|-----------------------|
| Interface                                  | RS232                             | USB 2.0. RS232        |
| Options                                    | CDRH and OEM versions             | CDRH and OEM versions |
|  | Available as PCB in eurocard size |                       |
| Operating voltage                          | 12 or 24 V                        | 12 or 24 V            |
| Operating current (at 24 V input voltage): |                                   |                       |
| Typical                                    | < 0.6 A                           | < 0.6 A               |
| Maximum                                    | 2 A                               | 2 A                   |
| Controller cable length                    | 1 or 2 m                          | 1 or 2 m              |

### Dimensions controller CKL 2400 [mm]:

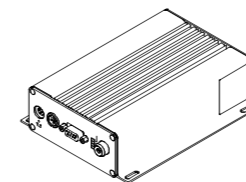
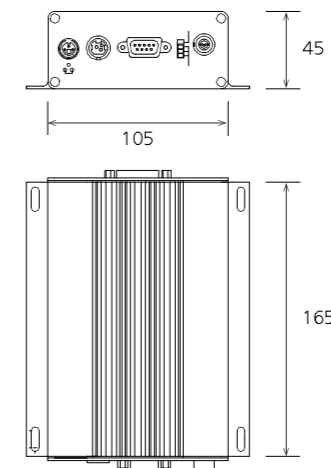

### Dimensions controller CKL 1000 [mm]:

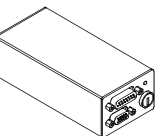
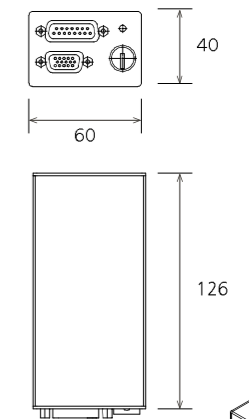

### Features of the LASOS® DPSS laser series:

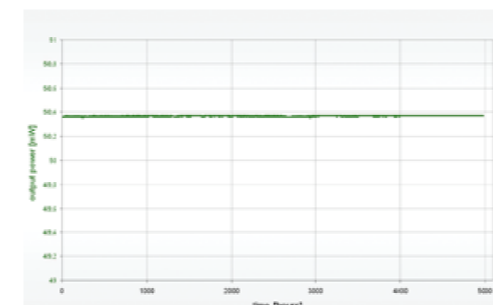

Excellent long-term power and pointing stability

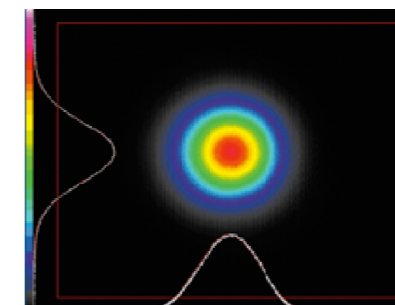

Exceptional good beam quality

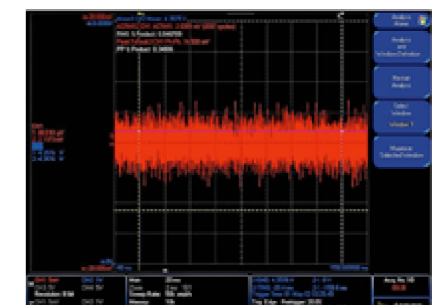

Low Noise